

4

3

2

1

A

B

C

D

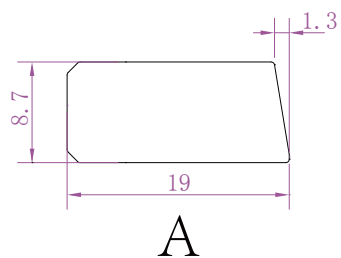
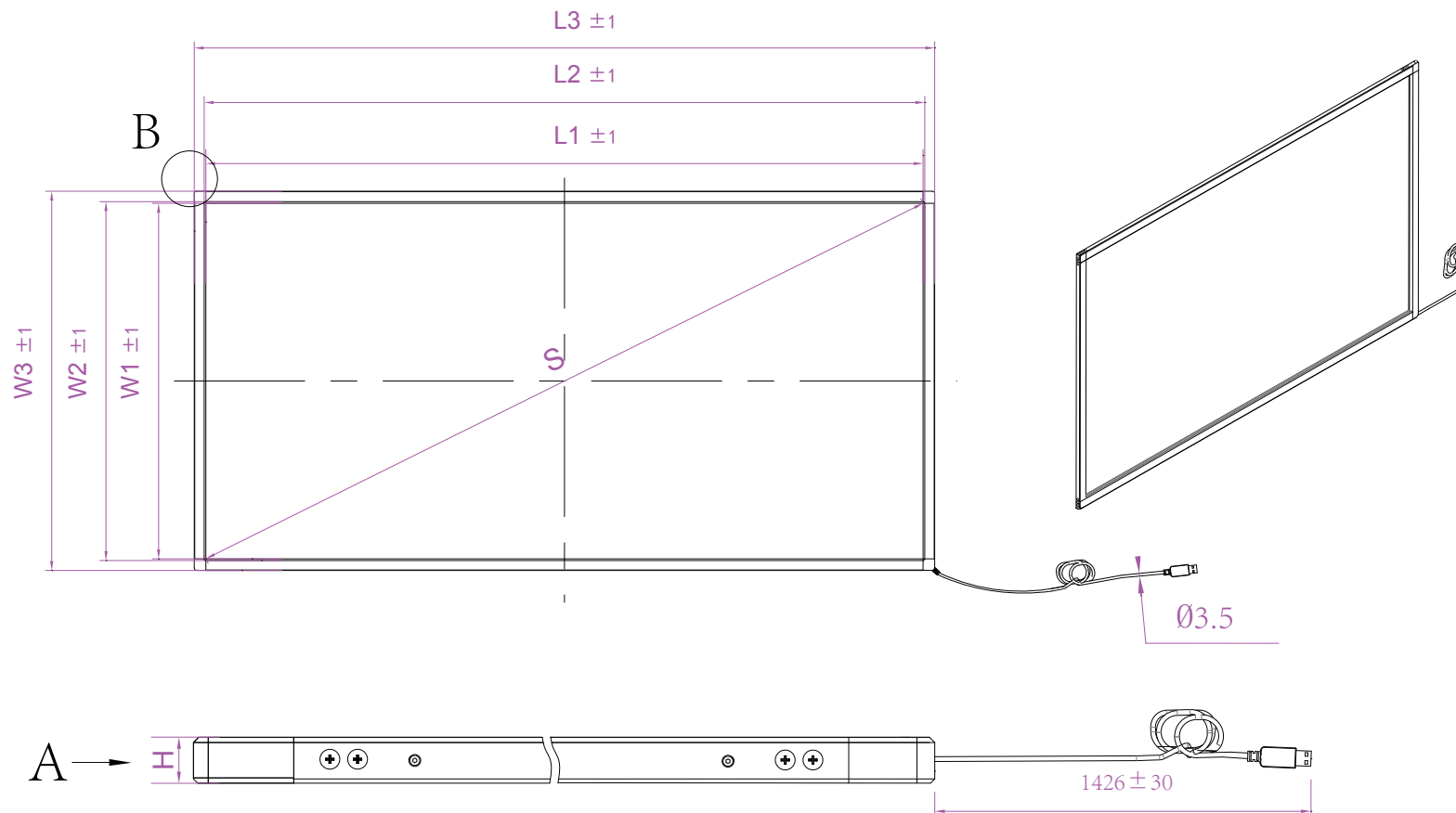
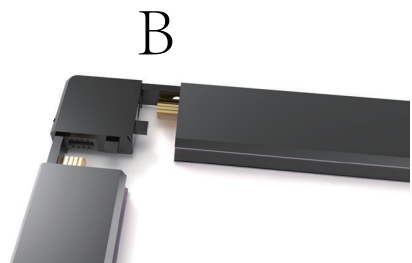

S(Inch/mm)	48.60"/1234.52
W1	608.2 ± 1
W2	610.8 ± 1
W3	646.2 ± 1
L1	1074.3 ± 1
L2	1076.9 ± 1
L3	1112.3 ± 1
H	8.7 ± 0.2



Anti-Sunlight, No Blind Zone For Any Size



X Slim Series							
Material:	aluminum	Unit:	mm	Date:		Rev:	1.0
Draft by:				Approved by:			

4

3

2

1