

4

3

2

1

A

B

C

D

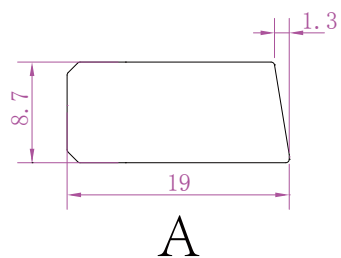
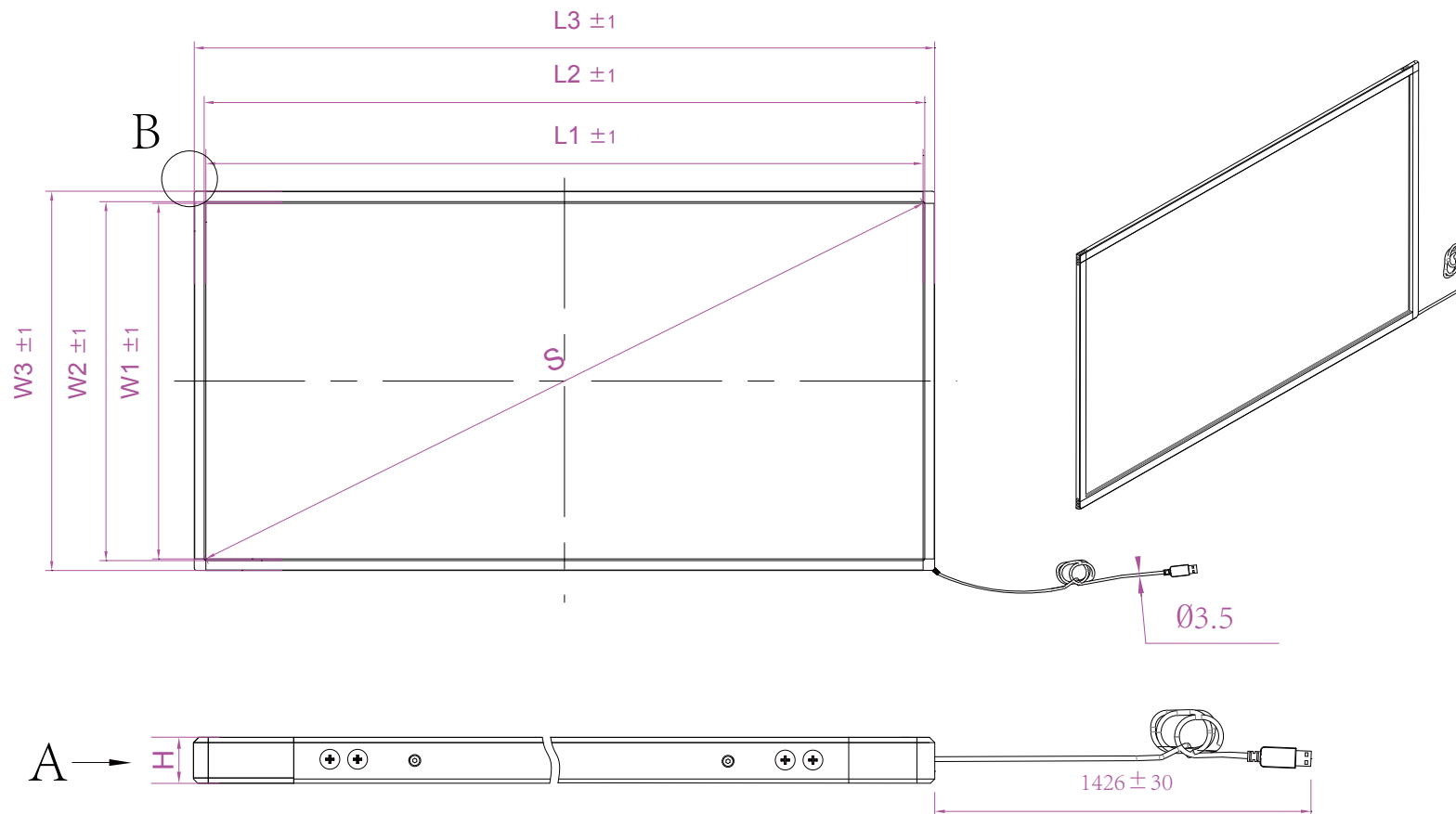
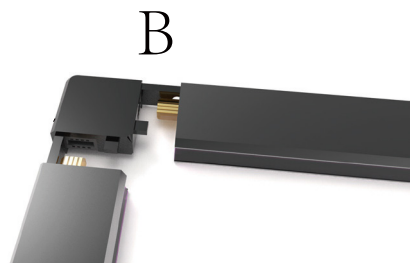

S(Inch/mm)	24.17"/613.94
W1	307.3 ± 1
W2	309.9 ± 1
W3	345.3 ± 1
L1	531.5 ± 1
L2	534.1 ± 1
L3	569.5 ± 1
H	8.7 ± 0.2



Anti-Sunlight, No Blind Zone For Any Size



X Slim Series							
Material:	aluminum	Unit:	mm	Date:		Rev:	1.0
Draft by:		Approved by:					

4

3

2

1