

4

3

2

1

A

B

C

D

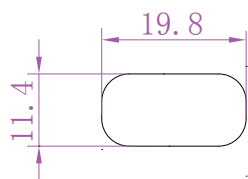
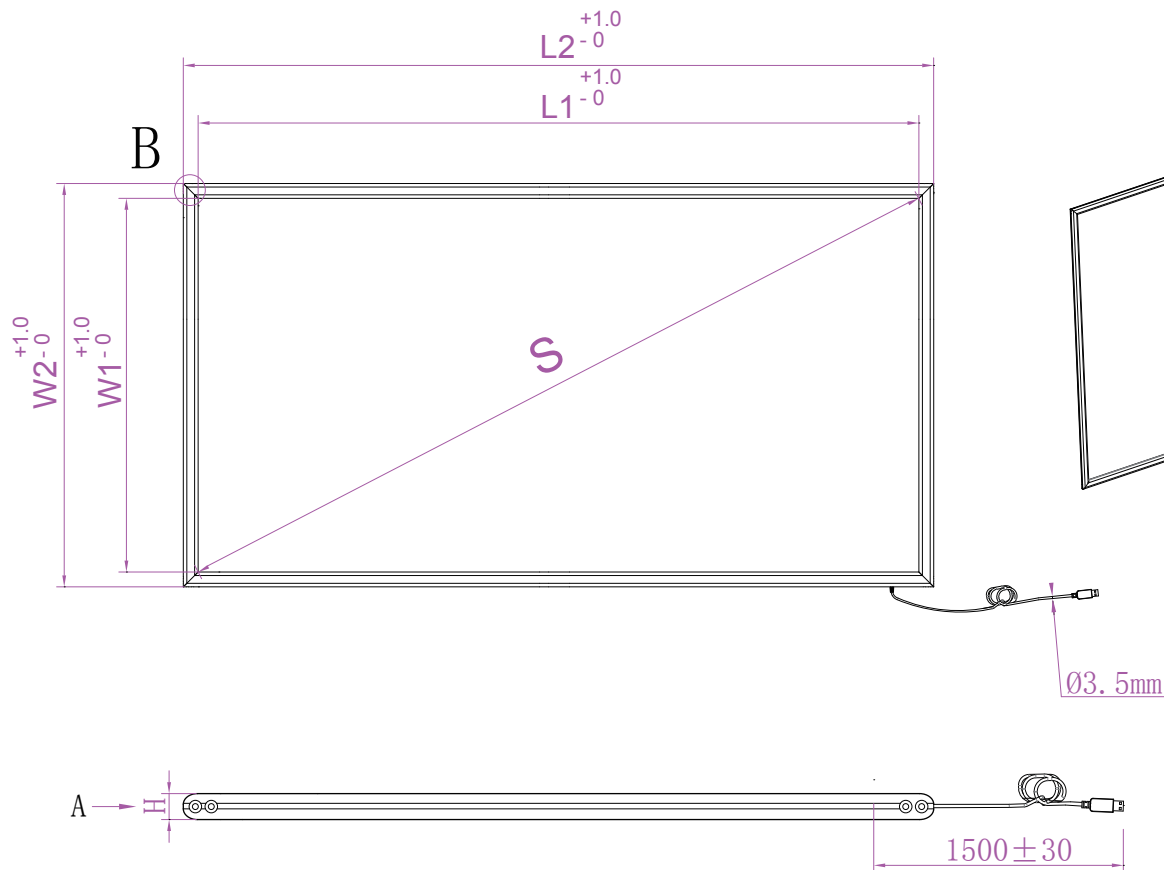

A

S(Inch/mm)	82.73"/2101.31
W1	1036.5(+1/-0)
W2	1076.1(+1/-0)
L1	1827.1(+1/-0)
L2	1866.7(+1/-0)
H	11.4 ±0.2



Anti-Sunlight, No Blind Zone For Any Size



Material:	plastic	Unit:	mm	Date:		Rev:	1.0
Draft by:				Approved by:			

4

3

2

1