

4

3

2

1

A



B

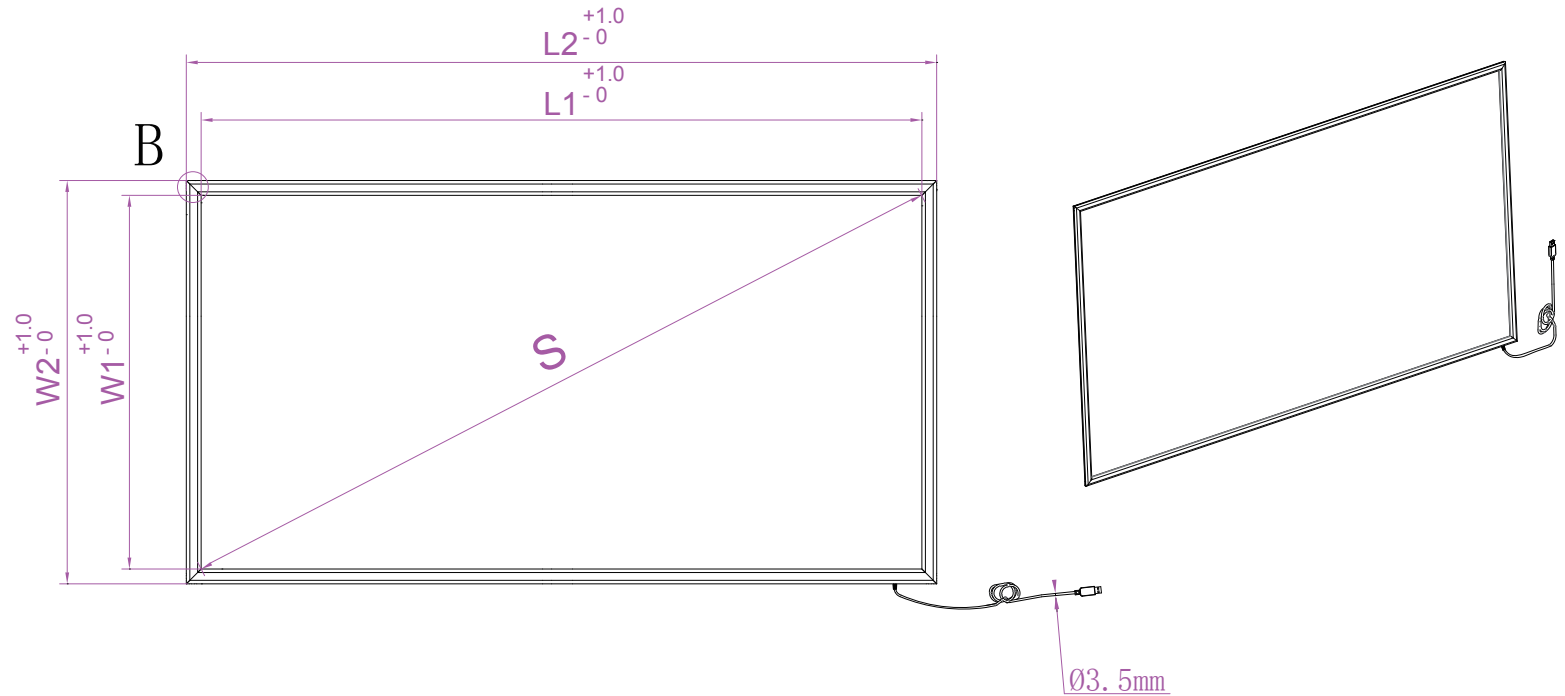

A

B

C

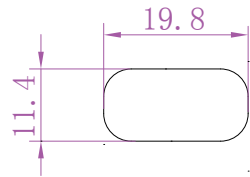

A

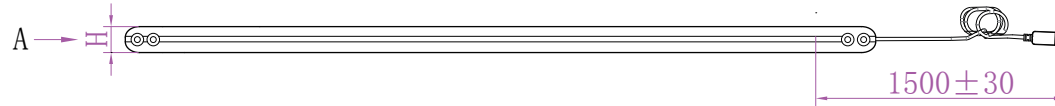

C

S(Inch/mm)	40.92"/1039.45
W1	517.3(+1/-0)
W2	556.9(+1/-0)
L1	900.8(+1/-0)
L2	940.4(+1/-0)
H	11.4 ±0.2



Anti-Sunlight, No Blind Zone For Any Size



D

Material:	plastic	Unit:	mm	Date:		Rev:	1.0
Draft by:				Approved by:			

4

3

2

1